

INSTRUCTION MANUAL

Router

RP0900

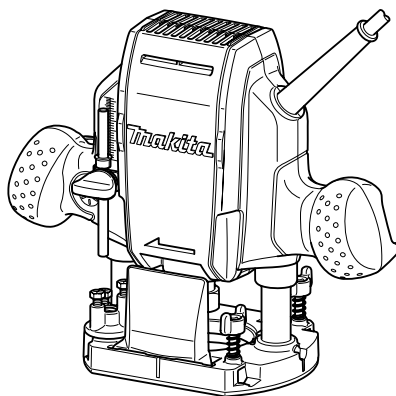

009743

 DOUBLE INSULATION

⚠WARNING:

For your personal safety, READ and UNDERSTAND before using.
SAVE THESE INSTRUCTIONS FOR FUTURE REFERENCE.

ENGLISH (Original instructions)

SPECIFICATIONS

Model	RP0900
Collet chuck capacity	6mm, 1/4", 8 mm and/or 3/8"
Plunge capacity	0 - 35 mm
No load speed (min ⁻¹)	27,000
Overall height	217 mm
Net weight	2.7 kg
Safety class	II/III

- Due to our continuing programme of research and development, the specifications herein are subject to change without notice.
- Note: Specifications may differ from country to country.
- Weight according to EPTA-Procedure 01/2003

END201-5

ENG223-2

Symbols

The following show the symbols used for the equipment. Be sure that you understand their meaning before use.



- Read instruction manual.



- DOUBLE INSULATION



- Only for EU countries
Do not dispose of electric equipment together with household waste material! In observance of European Directive 2002/96/EC on waste electric and electronic equipment and its implementation in accordance with national law, electric equipment that have reached the end of their life must be collected separately and returned to an environmentally compatible recycling facility.

ENE010-1

Intended use

The tool is intended for flush trimming and profiling of wood, plastic and similar materials.

ENF002-1

Power supply

The tool should be connected only to a power supply of the same voltage as indicated on the nameplate, and can only be operated on single-phase AC supply. They are double-insulated in accordance with European Standard and can, therefore, also be used from sockets without earth wire.

ENG102-3

Noise

The typical A-weighted noise level determined according to EN60745:

Sound pressure level (L_{pA}) : 89 dB(A)

Sound power level (L_{WA}) : 100 dB(A)

Uncertainty (K) : 3 dB(A)

Wear ear protection

Vibration

The vibration total value (tri-axial vector sum) determined according to EN60745:

Work mode : cutting grooves in MDF

Vibration emission (a_h) : 4.0 m/s²

Uncertainty (K) : 1.5 m/s²

ENG901-1

- The declared vibration emission value has been measured in accordance with the standard test method and may be used for comparing one tool with another.
- The declared vibration emission value may also be used in a preliminary assessment of exposure.

⚠WARNING:

- The vibration emission during actual use of the power tool can differ from the declared emission value depending on the ways in which the tool is used.
- Be sure to identify safety measures to protect the operator that are based on an estimation of exposure in the actual conditions of use (taking account of all parts of the operating cycle such as the times when the tool is switched off and when it is running idle in addition to the trigger time).

ENH101-13

For European countries only

EC Declaration of Conformity

We Makita Corporation as the responsible manufacturer declare that the following Makita machine(s):

Designation of Machine:

Router

Model No./ Type: RP0900

are of series production and

Conforms to the following European Directives:

98/37/EC until 28th December 2009 and then with 2006/42/EC from 29th December 2009

And are manufactured in accordance with the following standards or standardised documents:

EN60745

The technical documentation is kept by our authorised representative in Europe who is:

Makita International Europe Ltd,
Michigan, Drive, Tongwell,
Milton Keynes, MK15 8JD, England

30th January 2009



000230

Tomoyasu Kato
Director
Makita Corporation
3-11-8, Sumiyoshi-cho,
Anjo, Aichi, JAPAN

GEA005-3

General Power Tool Safety Warnings

⚠ WARNING Read all safety warnings and all instructions. Failure to follow the warnings and instructions may result in electric shock, fire and/or serious injury.

Save all warnings and instructions for future reference.

The term "power tool" in the warnings refers to your mains-operated (corded) power tool or battery-operated (cordless) power tool.

Work area safety

1. **Keep work area clean and well lit.** Cluttered or dark areas invite accidents.
2. **Do not operate power tools in explosive atmospheres, such as in the presence of flammable liquids, gases or dust.** Power tools create sparks which may ignite the dust or fumes.
3. **Keep children and bystanders away while operating a power tool.** Distractions can cause you to lose control.

Electrical safety

4. **Power tool plugs must match the outlet. Never modify the plug in any way. Do not use any adapter plugs with earthed (grounded) power tools.** Unmodified plugs and matching outlets will reduce risk of electric shock.
5. **Avoid body contact with earthed or grounded surfaces such as pipes, radiators, ranges and refrigerators.** There is an increased risk of electric shock if your body is earthed or grounded.

6. **Do not expose power tools to rain or wet conditions.** Water entering a power tool will increase the risk of electric shock.
7. **Do not abuse the cord. Never use the cord for carrying, pulling or unplugging the power tool. Keep cord away from heat, oil, sharp edges or moving parts.** Damaged or entangled cords increase the risk of electric shock.
8. **When operating a power tool outdoors, use an extension cord suitable for outdoor use.** Use of a cord suitable for outdoor use reduces the risk of electric shock.
9. **If operating a power tool in a damp location is unavoidable, use a residual current device (RCD) protected supply.** Use of an RCD reduces the risk of electric shock.
10. **Use of power supply via a RCD with a rated residual current of 30mA or less is always recommended.**

Personal safety

11. **Stay alert, watch what you are doing and use common sense when operating a power tool. Do not use a power tool while you are tired or under the influence of drugs, alcohol or medication.** A moment of inattention while operating power tools may result in serious personal injury.
12. **Use personal protective equipment. Always wear eye protection.** Protective equipment such as dust mask, non-skid safety shoes, hard hat, or hearing protection used for appropriate conditions will reduce personal injuries.
13. **Prevent unintentional starting. Ensure the switch is in the off-position before connecting to power source and/or battery pack, picking up or carrying the tool.** Carrying power tools with your finger on the switch or energising power tools that have the switch on invites accidents.
14. **Remove any adjusting key or wrench before turning the power tool on.** A wrench or a key left attached to a rotating part of the power tool may result in personal injury.
15. **Do not overreach. Keep proper footing and balance at all times.** This enables better control of the power tool in unexpected situations.
16. **Dress properly. Do not wear loose clothing or jewellery. Keep your hair, clothing, and gloves away from moving parts.** Loose clothes, jewellery or long hair can be caught in moving parts.
17. **If devices are provided for the connection of dust extraction and collection facilities, ensure these are connected and properly used.** Use of dust collection can reduce dust-related hazards.

Power tool use and care

18. **Do not force the power tool. Use the correct power tool for your application.** The correct power tool will do the job better and safer at the rate for which it was designed.
19. **Do not use the power tool if the switch does not turn it on and off.** Any power tool that cannot be controlled with the switch is dangerous and must be repaired.
20. **Disconnect the plug from the power source and/or the battery pack from the power tool before making any adjustments, changing accessories, or storing power tools.** Such preventive safety measures reduce the risk of starting the power tool accidentally.
21. **Store idle power tools out of the reach of children and do not allow persons unfamiliar with the power tool or these instructions to operate the power tool.** Power tools are dangerous in the hands of untrained users.
22. **Maintain power tools. Check for misalignment or binding of moving parts, breakage of parts and any other condition that may affect the power tool's operation. If damaged, have the power tool repaired before use.** Many accidents are caused by poorly maintained power tools.
23. **Keep cutting tools sharp and clean.** Properly maintained cutting tools with sharp cutting edges are less likely to bind and are easier to control.
24. **Use the power tool, accessories and tool bits etc. in accordance with these instructions, taking into account the working conditions and the work to be performed.** Use of the power tool for operations different from those intended could result in a hazardous situation.

Service

25. **Have your power tool serviced by a qualified repair person using only identical replacement parts.** This will ensure that the safety of the power tool is maintained.
26. **Follow instruction for lubricating and changing accessories.**
27. **Keep handles dry, clean and free from oil and grease.**

GEB018-2

ROUTER SAFETY WARNINGS

1. **Hold power tools by insulated gripping surfaces when performing an operation where the cutting tool may contact hidden wiring or its own cord.** Contact with a "live" wire will make exposed metal parts of the tool "live" and shock the operator.
2. **Use clamps or another practical way to secure and support the workpiece to a stable platform.**

Holding the work by hand or against your body leaves it unstable and may lead to loss of control.

3. **Wear hearing protection during extended period of operation.**
4. **Handle the bits very carefully.**
5. **Check the bit carefully for cracks or damage before operation. Replace cracked or damaged bit immediately.**
6. **Avoid cutting nails. Inspect for and remove all nails from the workpiece before operation.**
7. **Hold the tool firmly with both hands.**
8. **Keep hands away from rotating parts.**
9. **Make sure the bit is not contacting the workpiece before the switch is turned on.**
10. **Before using the tool on an actual workpiece, let it run for a while. Watch for vibration or wobbling that could indicate improperly installed bit.**
11. **Be careful of the bit rotating direction and the feed direction.**
12. **Do not leave the tool running. Operate the tool only when hand-held.**
13. **Always switch off and wait for the bit to come to a complete stop before removing the tool from workpiece.**
14. **Do not touch the bit immediately after operation; it may be extremely hot and could burn your skin.**
15. **Do not smear the tool base carelessly with thinner, gasoline, oil or the like. They may cause cracks in the tool base.**
16. **Draw attention to the need to use cutters of the correct shank diameter and which are suitable for the speed of the tool.**
17. **Some material contains chemicals which may be toxic. Take caution to prevent dust inhalation and skin contact. Follow material supplier safety data.**
18. **Always use the correct dust mask/respirator for the material and application you are working with.**

SAVE THESE INSTRUCTIONS.

WARNING:

DO NOT let comfort or familiarity with product (gained from repeated use) replace strict adherence to safety rules for the subject product. **MISUSE** or failure to follow the safety rules stated in this instruction manual may cause serious personal injury.

FUNCTIONAL DESCRIPTION

⚠CAUTION:

- Always be sure that the tool is switched off and unplugged before adjusting or checking function on the tool.

Adjusting the depth of cut

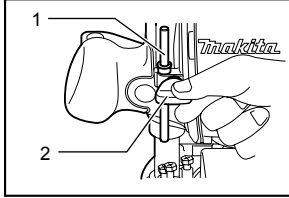

009744

1. Stopper pole
2. Screw

Place the tool on a flat surface. Loosen the screw securing the stopper pole.

Loosen the lock lever and lower the tool body until the bit just touches the flat surface. Tighten the lock lever to lock the tool body.

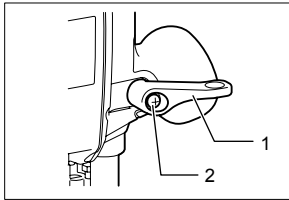

009745

1. Lock lever
2. Screw

Next, lower the stopper pole until it makes contact with the adjusting hex bolt. Align the depth pointer with the "0" graduation.

Raise the stopper pole until the desired depth of cut is obtained. The depth of cut is indicated on the scale (1 mm per graduation) by the depth pointer. Then tighten the screw to secure the stopper pole.

Now, your predetermined depth of cut can be obtained by loosening the lock lever and then lowering the tool body until the stopper pole makes contact with the adjusting hex bolt.

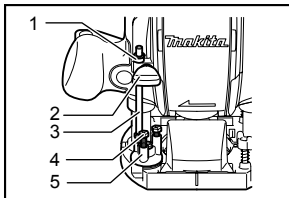

009746

1. Depth pointer
2. Screw
3. Stopper pole
4. Adjusting hex bolt
5. Stopper block

⚠CAUTION:

- Since excessive cutting may cause overload of the motor or difficulty in controlling the tool, the depth of cut should not be more than 15 mm at a pass when cutting grooves with an 8 mm diameter bit.
- When cutting grooves with a 20 mm diameter bit, the depth of cut should not be more than 5 mm at a pass.

When you wish to cut grooves more than 15 mm deep with an 8 mm diameter bit or more than 5 mm deep with a 20 mm diameter bit, make several passes with progressively deeper bit settings.

Stopper block

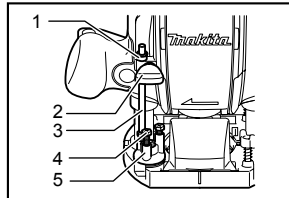

009746

1. Depth pointer
2. Screw
3. Stopper pole
4. Adjusting hex bolt
5. Stopper block

The stopper block has three adjusting hex bolts which raise or lower 0.8 mm per turn. You can easily obtain three different depths of cut using these adjusting hex bolts without readjusting the stopper pole.

Adjust the lowest hex bolt to obtain the deepest depth of cut, following the method of "Adjusting depth of cut". Adjust the two remaining hex bolts to obtain shallower depths of cut. The differences in height of these hex bolts are equal to the differences in depths of cut.

To adjust the hex bolts, turn the hex bolts. The stopper block is also convenient for making three passes with progressively deeper bit settings when cutting deep grooves.

⚠CAUTION:

When using a bit having total length of 60 mm or more, or edge length of 35 mm or more, the depth of cut cannot be adjusted as previously mentioned. To adjust, proceed as follows:

Loosen the lock lever and carefully adjust bit protrusion below the tool base to the desired depth of cut by moving the tool body up or down. Then retighten the lock lever to lock the tool body at that depth of cut. Keep the tool body locked at this position during use. Since the bit always protrudes from the tool base, be careful when handling the tool.

Adjusting the lock lever

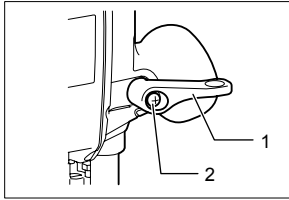

009745

1. Lock lever
2. Screw

The locked position of the lock lever is adjustable. To adjust it, remove the screw securing the lock lever. The lock lever will come off. Set the lock lever at the desired angle. After adjustment, tighten the lock lever clockwise.

Switch action

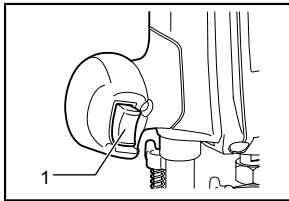

009747

1. Switch trigger

⚠CAUTION:

- Before plugging in the tool, always check to see that the switch trigger actuates properly and returns to the "OFF" position when released.

To start the tool, simply pull the switch trigger. Release the switch trigger to stop.

ASSEMBLY

⚠CAUTION:

- Always be sure that the tool is switched off and unplugged before carrying out any work on the tool.

Installing or removing the bit

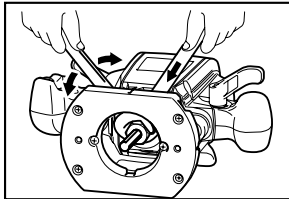

009748

⚠CAUTION:

- Install the bit securely. Always use only the wrenches provided with the tool. A loose or overtightened bit can be dangerous.
- Do not tighten the collet nut without inserting a bit. It can lead to breakage of the collet cone.

Insert the bit all the way into the collet cone and tighten the collet nut securely with the two wrenches.

A 6 mm or 1/4" collet cone is also provided as standard equipment besides the 8 mm or 3/8" collet cone that is factory installed on the tool. Use the correct size collet cone for the bit which you intend to use.

To remove the bit, follow the installation procedure in reverse.

OPERATION

Set the tool base on the workpiece to be cut without the bit making any contact. Then turn the tool on and wait until the bit attains full speed. Lower the tool body and move the tool forward over the workpiece surface, keeping the tool base flush and advancing smoothly until the cutting is complete.

When doing edge cutting, the workpiece surface should be on the left side of the bit in the feed direction.

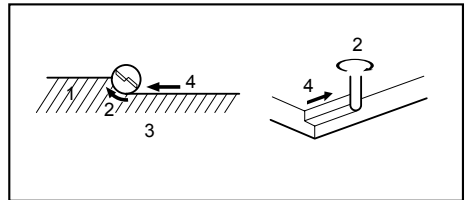

1. Workpiece
2. Bit revolving direction
3. View from the top of the tool
4. Feed direction

001984

NOTE:

- Moving the tool forward too fast may cause a poor quality of cut, or damage to the bit or motor. Moving the tool forward too slowly may burn and mar the cut. The proper feed rate will depend on the bit size, the kind of workpiece and depth of cut. Before beginning the cut on the actual workpiece, it is advisable to make a sample cut on a piece of scrap lumber. This will show exactly how the cut will look as well as enable you to check dimensions.
- When using the straight guide, be sure to install it on the right side in the feed direction. This will help to keep it flush with the side of the workpiece.

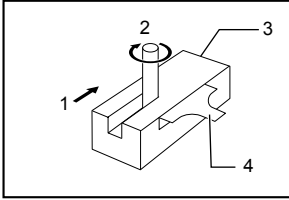

1. Feed direction
2. Bit revolving direction
3. Workpiece
4. Straight guide

001985

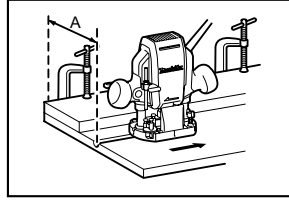

009751

Straight guide

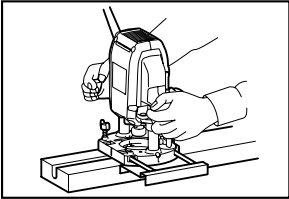

009749

The straight guide is effectively used for straight cuts when chamfering or grooving.

To install the straight guide, insert the guide bars into the holes in the tool base. Adjust the distance between the bit and the straight guide. At the desired distance, tighten the wing bolts to secure the straight guide in place.

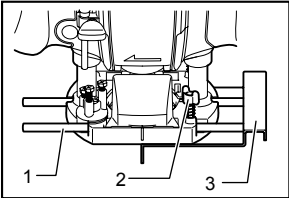

1. Guide bar
2. Clamp screw
3. Straight guide

009750

When cutting, move the tool with the straight guide flush with the side of the workpiece.

If the distance (A) between the side of the workpiece and the cutting position is too wide for the straight guide, or if the side of the workpiece is not straight, the straight guide cannot be used. In this case, firmly clamp a straight board to the workpiece and use it as a guide against the router base. Feed the tool in the direction of the arrow.

Templet guide (Accessory)

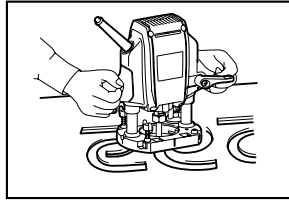

009752

The templet guide provides a sleeve through which the bit passes, allowing use of the tool with templet patterns.

To install the templet guide, loosen the screws on the tool base, insert the templet guide and then tighten the screws.

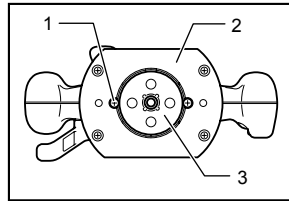

1. Screw
2. Base
3. Template guide

009753

Secure the templet to the workpiece. Place the tool on the templet and move the tool with the templet guide sliding along the side of the templet.

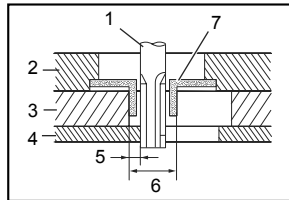

1. Bit
2. Base
3. Templet
4. Workpiece
5. Distance (X)
6. Outside diameter of the templet guide
7. Templet guide

003695

NOTE:

- The workpiece will be cut a slightly different size from the templet. Allow for the distance (X) between the bit and the outside of the templet guide. The distance (X) can be calculated by using the following equation:
Distance (X) = (outside diameter of the templet guide - bit diameter) / 2

Dust nozzle set (Accessory)

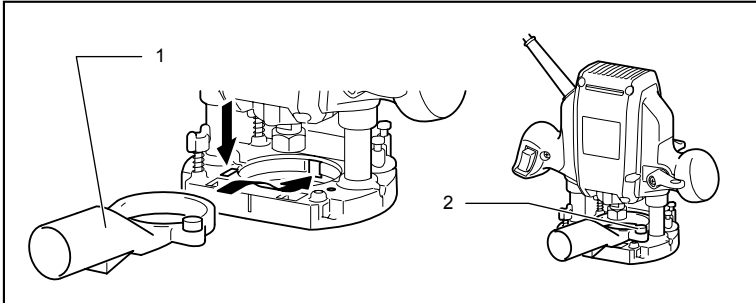

- 1. Dust nozzle
- 2. Thumb screw

009754

Use the dust nozzle for dust extraction. Install the dust nozzle on the tool base using the thumb screw so that protrusion on the dust nozzle fit to the notch in the tool base.

Then connect a vacuum cleaner to the dust nozzle.

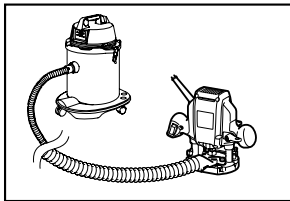

009755

MAINTENANCE

⚠CAUTION:

- Always be sure that the tool is switched off and unplugged before attempting to perform inspection or maintenance.
- Never use gasoline, benzene, thinner, alcohol or the like. Discoloration, deformation or cracks may result.

To maintain product SAFETY and RELIABILITY, repairs, any other maintenance or adjustment should be performed by Makita Authorized Service Centers,

always using Makita replacement parts.

ACCESSORIES

⚠CAUTION:

- These accessories or attachments are recommended for use with your Makita tool specified in this manual. The use of any other accessories or attachments might present a risk of injury to persons. Only use accessory or attachment for its stated purpose.

If you need any assistance for more details regarding these accessories, ask your local Makita Service Center.

- Straight & groove forming bits
- Edge forming bits
- Laminate trimming bits
- Straight guide
- Templet guide 25
- Templet guides
- Templet guide adapter
- Lock nut
- Collet cone 3/8", 1/4"
- Collet cone 6 mm, 8 mm
- Wrench 13
- Wrench 22
- Dust nozzle set

Router bits

Straight bit

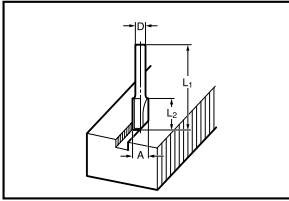

005116

mm			
D	A	L 1	L 2
6	20	50	15
1/4"			
8	8	60	25
6	8	50	18
1/4"			
6	6	50	18
1/4"			

009802

"U"Grooving bit

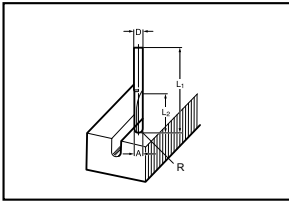

005117

mm				
D	A	L 1	L 2	R
6	6	50	18	3

009803

"V"Grooving bit

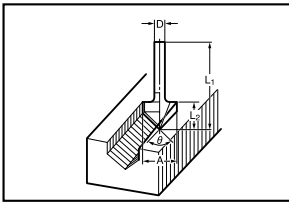

005118

mm				
D	A	L 1	L 2	θ
1/4"	20	50	15	90°

009804

Drill point flush trimming bit

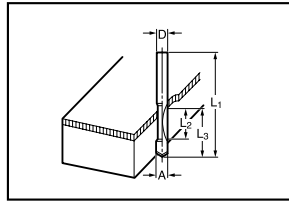

005120

mm				
D	A	L 1	L 2	L 3
8	8	60	20	35
6	6	60	18	28

009806

Drill point double flush trimming bit

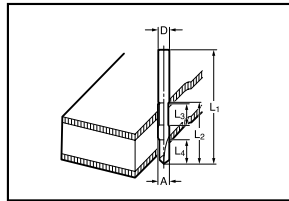

005121

mm					
D	A	L 1	L 2	L 3	L 4
8	8	80	55	20	25
6	6	70	40	12	14

009807

Corner rounding bit

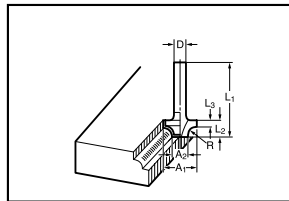

005125

mm						
D	A 1	A 2	L 1	L 2	L 3	R
6	25	9	48	13	5	8
6	20	8	45	10	4	4

009808

Chamfering bit

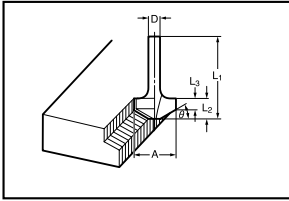

005126

mm					
D	A	L 1	L 2	L 3	θ
6	23	46	11	6	30°
6	20	50	13	5	45°
6	20	49	14	2	60°

009809

Ball bearing corner rounding bit

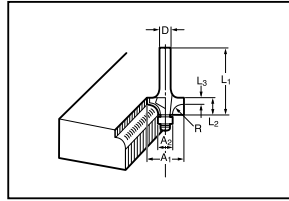

005131

mm						
D	A 1	A 2	L 1	L 2	L 3	R
6	15	8	37	7	3.5	3
6	21	8	40	10	3.5	6
1/4"						

009812

Cove beading bit

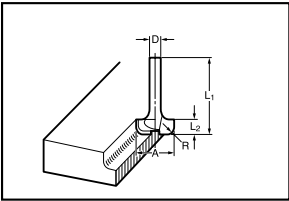

005129

mm				
D	A	L 1	L 2	R
6	20	43	8	4
6	25	48	13	8

009810

Ball bearing chamfering bit

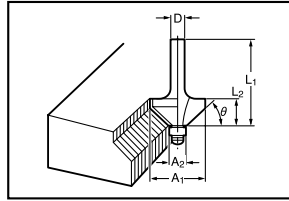

005132

mm					
D	A 1	A 2	L 1	L 2	θ
6	26	8	42	12	45°
1/4"					60°
6	20	8	41	11	60°

009813

Ball bearing flush trimming bit

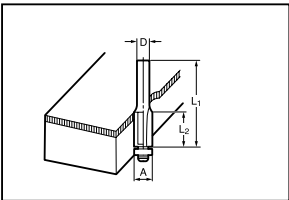

005130

mm			
D	A	L 1	L 2
6	10	50	20
1/4"			

009811

Ball bearing beading bit

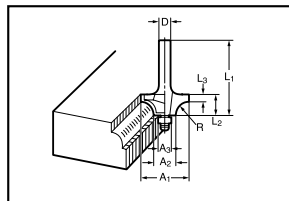

005133

mm							
D	A 1	A 2	A 3	L 1	L 2	L 3	R
6	20	12	8	40	10	5.5	4
6	26	12	8	42	12	4.5	7

009814

Ball bearing cove beading bit

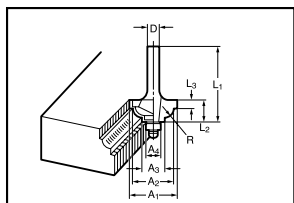

005134

D	A 1	A 2	A 3	A 4	L 1	L 2	L 3	R
6	20	18	12	8	40	10	5.5	3
6	26	22	12	8	42	12	5	5

009815

Ball bearing roman ogee bit

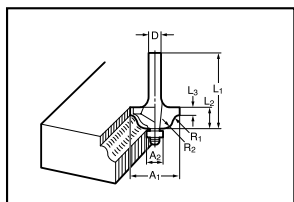

005135

D	A 1	A 2	L 1	L 2	L 3	R 1	R 2
6	20	8	40	10	4.5	2.5	4.5
6	26	8	42	12	4.5	3	6

009816

Makita Corporation Anjo, Aichi, Japan